

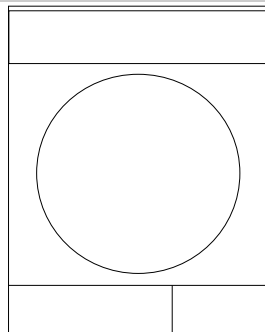

*Dryer*  
*User manual*

*3880 KT*



# Please read this user manual first!

Dear Customer,

Thank you for preferring a Arçelik product. We hope that your product which has been manufactured with high quality and technology will give you the best results. We advise you to read through this manual and the other accompanying documentation carefully before using your product and keep it for future reference. If you transfer the product to someone else, give its manual as well. Pay attention to all details and warnings specified in the user manual and follow the instructions given therein.



Use this user manual for the model indicated on the cover page.



Read the instructions.

## Explanation of symbols

Throughout this user manual the following symbols are used:

	Important information or useful hints about usage.
	Warning for hazardous situations with regard to life and property.
	Warning against electric shock.
	Warning against hot surfaces.
	Warning against fire hazard.
	Packaging materials of the product are manufactured from recyclable materials in accordance with our National Environment Regulations.

Do not dispose of the packaging wastes with the domestic waste or other wastes, discard them to the dedicated collection points designated by the local authorities.



This product was manufactured using the latest technology in environmentally friendly conditions.

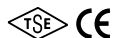

WEEE It complies with the WEEE Directive

# 1 Important instructions for safety and environment

This section contains safety instructions that will help protect from risk of personal injury or property damage. Failure to follow these instructions shall void any warranty.

## 1.1 General safety

- The dryer can be used by children at and above 8 years old and by persons whose physical, sensory or mental capabilities were not fully developed or who lack experience and knowledge provided that they are supervised or trained on the safe usage of the product and the risks it brings out. Children should not play with the product. Cleaning and maintenance works should not be performed by children unless they are supervised by someone.
- Children of less than 3 years should be kept away unless continuously supervised.
- Adjustable feet should not be removed. The gap between the dryer and the floor should not be reduced with materials such as carpet, wood and tape. This will cause problems with the dryer.
- Always have the installation and repairing procedures carried out by the **Authorized Service**. Manufacturer shall not be held liable for damages that may arise from procedures carried out by unauthorized persons.
- Never wash the dryer by spraying or pouring water onto it! There is the risk of electric shock!

# Important safety and environmental instructions

## 1.1.1 Electrical safety



Electrical safety instructions should be followed while electrical connection is made during the installation.



The appliance must not be supplied through an external switching device, such as a timer, or connected to a circuit that is regularly switched on and off by utility.

- Connect the dryer to a grounded outlet protected by a fuse at the value specified on the type label. Have the grounding installation performed by a qualified electrician. Our company shall not be liable for any damages that will arise when the dryer is used without grounding in accordance with the local regulations.
- The voltage and allowed fuse protection is stated on the type label plate.
- The voltage specified on the type label must be equal to your mains voltage.
- Unplug the dryer when it is not in use.
- Unplug the dryer from the mains during installation, maintenance, cleaning and repair works.
- Do not touch the plug with wet hands! Never unplug by pulling on the cable, always pull out by grabbing the plug.
- Do not use extension cords, multi-plugs or adaptors to connect the dryer to power supply in order to decrease the risk of fire and electric shock.
- Power cable plug must be easily accessible after installation.



Damaged mains cable should be changed notifying the Authorized Service.



If the dryer is faulty, it must not be operated unless it is repaired by an authorized service agent! There is the risk of electric shock!

# Important safety and environmental instructions

## 1.1.2 Product safety



### **Points to be taken into consideration for fire hazard:**

Below specified laundry or items must not be dried in the dryer considering fire hazard.

- Unwashed laundry items
- Items soiled with oil, acetone, alcohol, fuel oil, kerosene, stain removers, turpentine, paraffin or paraffin removers must be washed in hot water with plenty of detergent before being dried in the dryer.

For this reason especially the items containing the above specified stains must be washed very well, to do this use adequate detergent and choose a high washing temperature.



### **Below specified laundry or items must not be dried in the dryer due to the fire hazard:**

- Garments or pillows bolstered with rubber foam (latex foam), shower bonnets, water resistant textiles, materials with rubber reinforcement and rubber foam pads.
- Clothing cleaned with industrial chemicals.

Items such as lighter, match, coins, metal parts, needle etc. may damage the drum set or may lead to functional problems. Therefore check all the laundry that you will load into your dryer. Never stop your dryer before the programme completes. If you must do this, remove all laundry quickly and lay them out to dissipate the heat.



Clothes that are washed inadequately may ignite on their own and even may ignite after drying ends.

- You must provide enough ventilation in order to prevent gases exiting from devices operating with other types of fuels including the naked flame from accumulating in the room due to the back fire effect.

## Important safety and environmental instructions



Underwear that contains metal reinforcements should not be dried in the dryer. Dryer may be damaged if metal reinforcements come loose and break off during drying.



Use softeners and similar products in accordance with the instructions of their manufacturers.



Always clean the lint filter before or after each loading. Never operate the dryer without the lint filter installed.

- Never attempt to repair the dryer by yourself. Do not perform any repair or replacement procedures on the product even if you know or have the ability to perform the required procedure unless it is clearly suggested in the operating instructions or the published service manual. Otherwise, you will be putting your life and others' lives in danger.
- There must not be a lockable, sliding or hinged door that may block the opening of the loading door in the place where your dryer is to be installed.
- Install your dryer at places suitable for home use. (Bathroom, closed balcony, garage etc.)
- Make sure that pets do not enter the dryer. Check the inside of the dryer before operating it.
- Do not lean on the loading door of your dryer when it is open, otherwise it may fall over.
- The lint must not be allowed to accumulate around the tumble dryer

# Important safety and environmental instructions

## 1.2 Mounting over a washing machine

- A fixing device should be used between the two machines when installing the dryer above a washing machine. The fitting device must be installed by the authorized service agent.
- Total weight of the washing machine and the dryer -with full load- when they are placed on top of each other reaches to approx. 180 kilograms. Place the products on a solid floor that has sufficient load carrying capacity!



Washing machine cannot be placed on the dryer. Pay attention to the above warnings during the installation on your washing machine.

**Installation Table for Washing Machine and Dryer**

Dryer Depth	Washing Machine Depth						
	62 cm	60 cm	54 cm	50 cm	49 cm	45 cm	40 cm
54 cm	Can be installed					Can be installed	Cannot be installed
60 cm	Can be installed					Cannot be installed	

# Important safety and environmental instructions

## 1.3 Intended use

- Dryer has been designed for domestic use. It is not suitable for commercial use and it must not be used out of its intended use.
- Use the dryer only for drying laundry that are marked accordingly.
- The manufacturer waives any responsibility arisen from incorrect usage or transportation.
- The service life of the dryer that you purchased is 10 years. During this period, original spare parts will be available to operate the dryer properly.

## 1.4 Child safety

- Packaging materials are dangerous for the children. Keep packaging materials away from children.
- Electrical products are dangerous for the children. Keep children away from the product when it is operating. Do not let them tamper with the dryer. Use the child-proof lock in order to prevent the children to tamper with the dryer.



Child-proof lock is on the control panel. **(See Child lock)**

- Keep loading door closed even when the dryer is not in use.

# Important safety and environmental instructions

## 1.5 Compliance with the WEEE regulation and disposing of the waste product



This product complies with EU WEEE Directive (2012/19/EU). This product bears a classification symbol for waste electrical and electronic equipment (WEEE).

This product has been manufactured with high quality parts and materials which can be reused and are suitable for recycling. Do not dispose of the waste product with normal domestic and other wastes at the end of its service life. Take it to the collection center for the recycling of electrical and electronic equipment. Please consult your local authorities to learn about these collection centers.

## 1.6 Compliance with RoHS Directive:

The product you have purchased complies with EU RoHS Directive (2011/65/EU). It does not contain harmful and prohibited materials specified in the Directive.

## 1.7 Package information

Packaging materials of the product are manufactured from recyclable materials in accordance with our National Environment Regulations. Do not dispose of the packaging materials together with the domestic or other wastes. Take them to the packaging material collection points designated by the local authorities.

# Important safety and environmental instructions

## 1.8 Technical Specifications



EN	
Height (Min. / Max.)	84,6 cm / 86,6 cm*
Width	59,5 cm
Depth	60,9 cm
Capacity (max.)	8 kg**
Net weight (plastic front door usage)	49 kg
Net weight (glass front door usage)	51 kg
Voltage	See type label***
Rated power input	
Model code	

\* Min. height: Height with adjustable feet are closed.

Max. height: Height with adjustable feet are opened maximum.

\*\* Dry laundry weight before washing.

\*\*\* Type label is located behind the loading door.

	Technical specifications of the dryer are subject to specification without notice to improve the quality of the product.
	Figures in this manual are schematic and may not match the product exactly.
	Values stated on markers on the dryer or in the other published documentation accompanying with the dryer are obtained in laboratory in accordance with the relevant standards. Depending on operational and environmental conditions of the dryer, these values may vary.

## 2 Your Dryer

### 2.1 Overview

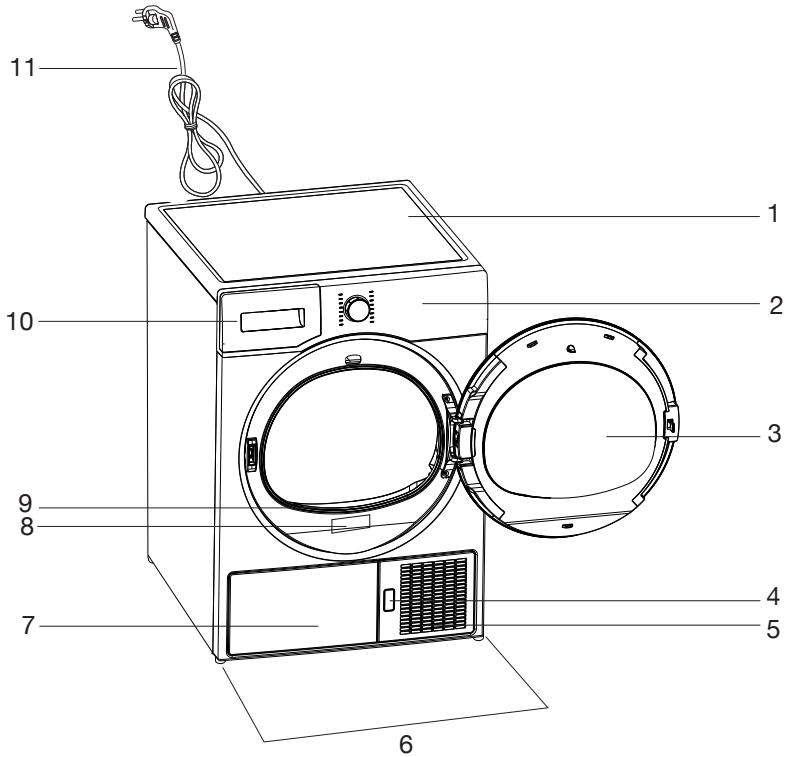

1. Top panel
2. Control panel
3. Loading door
4. Kick plate opening button
5. Ventilation grids
6. Adjustable legs
7. Kick plate
8. Type label
9. Lint filter
10. Water tank drawer
11. Power cord

# Your Dryer

## 2.2 Package Contents

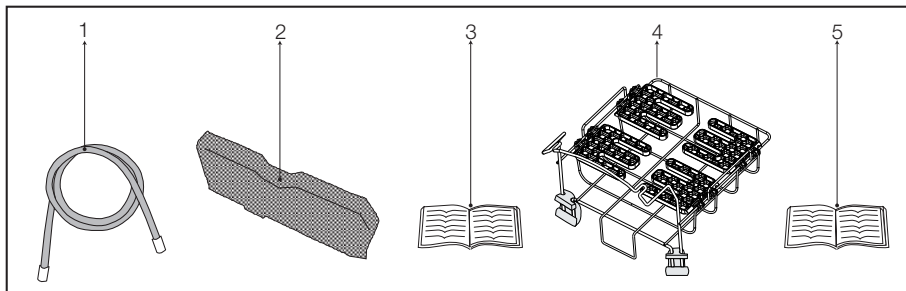



1. Water drain hose \*
2. Filter drawer spare sponge\*
3. User Manual
4. Drying basket\*
5. Drying basket user manual\*

\*It can be supplied with your machine depending on its model.

### 3 Installation

Refer to the nearest Authorized Service Agent for installation of the product. To make the product ready for use, make sure that the electricity and water drainage systems are appropriate by reading the information/instructions given in the user manual before calling the Authorized Service Agent. If they are not, call a qualified technician and plumber to have any necessary arrangements carried out.

	Preparation of the product's location as well as the electrical, clean water and waste water installations is under customer's responsibility.
	<b>CAUTION:</b> Installation and electrical connections of the product must be performed by the Authorized Service Agent. Manufacturer shall not be held liable for damages that may arise from procedures carried out by unauthorized persons.
	<b>CAUTION:</b> Prior to installation, visually check if the product has any defects on it. If so, do not have it installed. Damaged products cause risks for your safety.

### 3.1 Appropriate installation location

- Install the product on a stable and level surface.
- Dryer is heavy. Do not move it by yourself.
- Operate your product in a well ventilated, dust-free environment.
- Do not block the air ducts in front of and under the product with materials such as long pile rugs, wooden blocks and bands.
- Do not install the product behind a door with a lock, sliding door or a hinged door which can strike the product.
- Once the product is installed, it should stay at the same place where its connections have been made. When installing the product, make sure that the rear wall of it does not touch anywhere (tap, socket, etc.). Also pay attention to select an installation location which you will not be required to change afterwards.
- Place the product at least 1.5 cm away from the edges of other furniture.
- The rear surface of the tumble dryer shall be placed against a wall.

	<b>CAUTION:</b> Do not place the product on top of the power cord.
--	--

### 3.2 Removing the transportation safety assembly



**CAUTION:** Remove the transportation safety assembly before using the product for the first time.

1. Open the loading door.
2. There is a nylon bag inside the drum that contains a piece of styrofoam. Hold it from its section marked with **XX XX**.
3. Pull the nylon towards yourself and remove the transportation safety assembly.

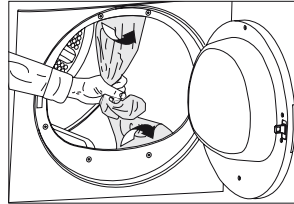

**CAUTION:** Check that no part of the transportation safety assembly remains inside the drum.

### 3.3 Under counter installation

This product can be installed under a counter if the height of the counter is sufficient.



**CAUTION:** While using the under counter dryer, never operate the dryer without under counter installation part.

Dryer Depth	60 cm	54 cm
Stock number of under-bench installation part	2979700200	2973600200

Leave at least 3 cm of space around the sides and the rear wall of the product when installing it under a counter or in a cupboard.

## Installation

### 3.4 Connecting to the drain

In products equipped with condenser unit, water accumulates in the water tank during the drying cycle. You should drain accumulated water after each drying cycle.

You can directly drain accumulated water through the water drain hose supplied with the product instead of periodically draining the water collected in the water tank.

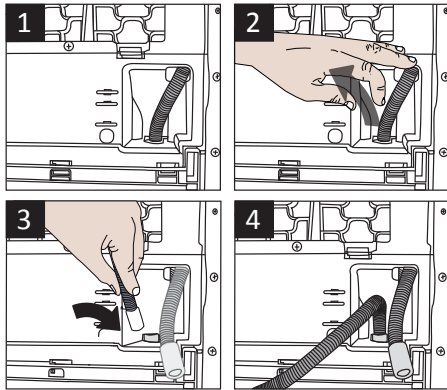

#### Connecting the water drain hose

- 1-2 Pull hose at the behind of the dryer by hand in order to disconnect it from where it is connected. Do not use any tools to remove the hose.
- 3 Connect one end of the drain hose supplied with the dryer to the connection point from where you removed the hose of the product in previous step.
- 4 Connect the other end of the drain hose directly to the wastewater drain or to the washbasin.



**CAUTION:** Hose must be fixed in every type of connection. Your house will be flooded if the hose comes loose during water discharge.



Attach the water drain hose to a height of maximum 80 cm.



Make sure that the water drain hose is not stepped on, twisted or bent between the drain and the machine.

### 3.5 Adjusting the feet

In order to ensure that the product operates more silently and vibration-free, it must stand level and balanced on its feet. Balance the machine by adjusting the feet.

Turn the feet to left or right until the machine stands level and firmly.

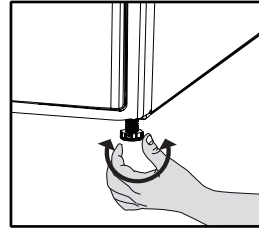

**CAUTION:** Never unscrew the adjustable feet from their housings.

### 3.6 Electrical connection

For specific instructions for electrical connection required during installation (see 1.1.1 Electrical Safety)



**CAUTION:** If the product is faulty, it must not be operated unless it is repaired! There is the risk of electric shock!

### 3.7 Transportation of the product

1. Unplug the product before transporting it.
2. Remove the water drain (if any) and chimney connections.
3. Drain the water in the product completely.

## Installation

### 3.8 Warnings about sounds



It is normal to hear a metallic noise from the compressor sometimes during operation.

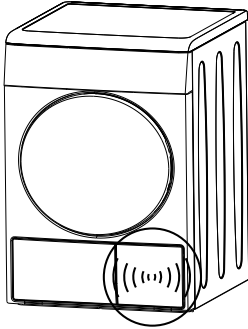

Water collected during operation is pumped to water tank. It is normal to hear pumping noise during this process.

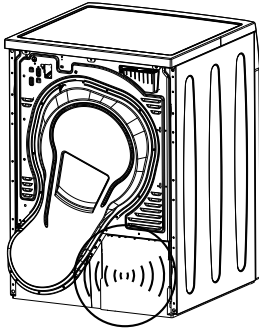

### 3.9 Changing the illumination lamp

In case an illumination lamp is used in your laundry dryer  
To change the Bulb/LED used for illumination of your tumble dryer, call your Authorized Service.

The lamp(s) used in this appliance is not suitable for household room illumination. The intended purpose of this lamp is to assist the user to place laundry in the tumble dryer in a comfortable way. "The lamps used in this appliance have to withstand extreme physical conditions such as vibrations and temperatures above 50 °C."

## 4 Preparation

### 4.1 Laundry suitable for drying in the dryer

Always obey the instructions given on the garment tags. Dry only the laundry having a label stating that they are suitable for drying in a dryer and make sure that you select the appropriate programme.

LAUNDRY DRYING SYMBOLS																							
	Drying Symbols		Suitable for dryer		No Iron		Sensitive / Delicate dry		Do not dry with dryer		Do not dry		Do not dry-clean										
	Drying Settings		At any temperature		At high temperature		At medium temperature		At low temperature		Without heating		Hang to dry		Lay to dry		Hang wet to dry		Lay in shadow to dry		Dry-cleanable		
	IRON	Iron -		Iron at high temperature		Iron at medium temperature		Iron at low temperature		Do not iron		Iron without steam											
		Dry or Steam																					
		Maximum temperature		200 °C		150 °C		110 °C															

### 4.2 Laundry not suitable for drying in the dryer



Delicate embroidered fabrics, woollen, silk garments, delicate and valuable fabrics, airtight items and tulle curtains are not suitable for machine drying.

### 4.3 Preparing laundry for drying

- Laundry may be tangled with each other after washing. Separate the laundry items before placing them into the dryer.
- Dry garments having metal accessories such as zippers, inside out.
- Fasten the zippers, hooks and buckles and button sheets.

### 4.4 Things to be done for energy saving

- Following information will help you use the dryer in an ecological and energy-efficient manner.
- Spin your laundry at the highest speed possible when washing them. Thus, the drying time is shortened and energy consumption is reduced.
- Sort out the laundry depending on their type and thickness. Dry the same type of laundry together. For example thin kitchen towels and table clothes dries earlier than thick bathroom towels.
- Follow the instructions in the user manual for programme selection.
- Do not open the loading door of the machine during drying unless necessary. If you must certainly open the loading door, do not to keep it open for a long time.
- Do not add wet laundry while the dryer is in operation
- Clean the lint filter before or after each drying cycle. **(See 6.1 Cleaning Lint Filter / Loading Door Inner Surface)**

- Clean the filter periodically when there is visible air collection on it or when the symbol lights up, if there is a filter drawer cleaning warning symbol «  » available. (See 6. 4 Cleaning the filter drawer)
- Ventilate the room, where the dryer is located, well during drying.

## 4.5 Correct load capacity

Follow the instructions in the “Programme selection and consumption table”. Do not load more than the capacity values stated in the table.

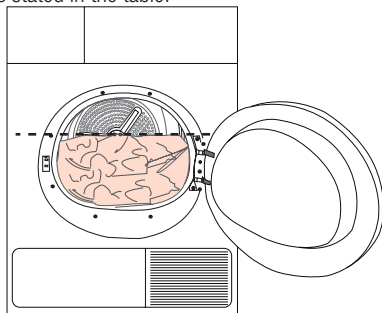

It is not recommended to load the dryer with laundry exceeding the level indicated in the figure. Drying performance will degrade when the machine is overloaded. Furthermore, dryer and the laundry can get damaged.

Following weights are given as examples.

Laundry	Approximate weights (g)*
Cotton quit covers (double)	1500
Cotton quit covers (single)	1000
Bed sheets (double)	500
Bed sheets (single)	350
Large tablecloths	700
Small tablecloths	250
Tea napkins	100
Bath towels	700
Hand towels	350
Blouses	150
Cotton shirts	300
Shirts	250
Cotton dresses	500
Dresses	350
Jeans	700
Handkerchiefs (10 pieces)	100
T-Shirts	125

\*Dry laundry weight before washing.

## 5 Program selection and operating your machine

### 5.1 Control Panel

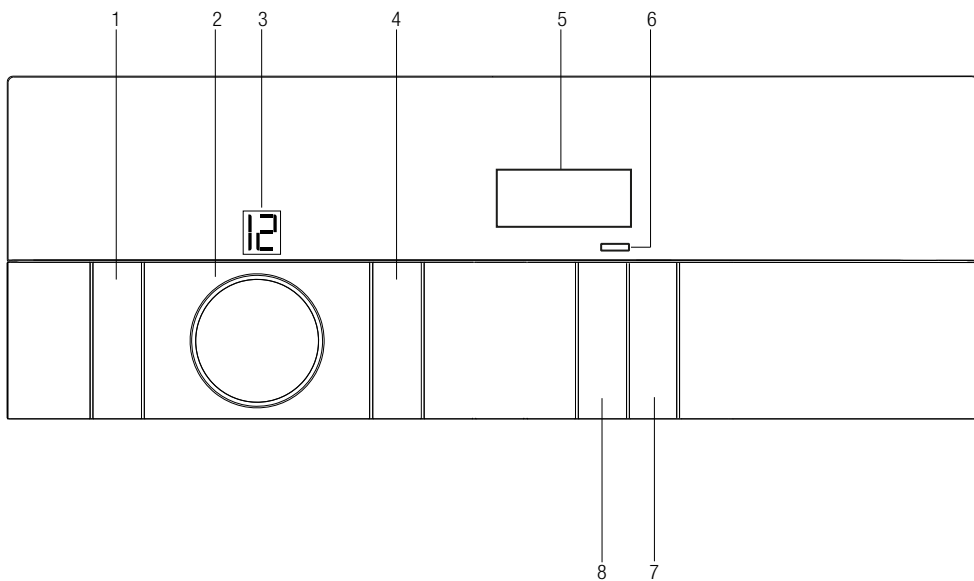

1. On/Off/Cancel button
2. Program button
3. Program number indicator
4. Sound warning level button/child lock
5. Remaining time indicator
6. Delayed operation setting LED
7. Start/Stand-by button
8. Time delay selection button

## Operating the product

### 5.2 Preparing the Machine

1. Plug the machine"
2. Place laundry into the machine.
3. Press **On/Off/Cancel** button for 1 second (long).
4. When your machine is turned on for the first time, it turns on with the declaration program (cotton wardrobe dry).



Pressing the On/Off/Cancel button does not mean that the program started. Press the Start / Stand-by button to start the program.

### 5.3 Program selection

1. Determine the suitable program from the table below where drying levels are presented.
2. Use the **Program Selection** button to select the program you wish.

Extra Dry	Only cotton clothes are dried under normal temperature. Thick and multi-layered laundry (towels, bed sheets, denim trousers etc.) are dried so that they can be placed in wardrobe without ironing.
Wardrobe Dry	Normal laundry (tablecloths, underwear etc.) are dried so that they can be placed in wardrobe without ironing.
Iron Dry	Normal laundry (shirts, dresses etc.) are dried to be ready for ironing.



For detailed program information, see „Program selection and consumption chart“..

### 5.4 Main programs

The following main programs are available depending on fabric type.

#### • Cotton

Dry durable laundry with this program. It dried under normal temperature. It is recommended for your cotton laundry (bedsheets, bedding, towel, bathrobe etc.)

#### • Synthetic

Dry sensitive laundry with this program. It is recommended for your synthetic laundry.

### 5.5 Additional programs

The following additional programs are available in the machine for special situations.



Additional programs may vary depending on the features of your machine.

#### • Mixed

Use to dry synthetic and cotton clothes that don't give out colour together.



To get better results from drying machine programs, your laundry should be washed with suitable program in your washing machine and wrung with recommended wringing speed.

#### • Shirt

Dries shirts more delicately and causes less wrinkles for easy ironing.



Shirt might remain slightly damp at the end of the program. It is recommended not to leave the shirts inside the drying machine.

#### • Jeans

Use to dry denim clothes wrung in the washing machine with high speed.

#### • Sport

Use to dry clothes made out of synthetic, cotton or mixed fabrics.

#### • Daily

The program used for daily drying of cotton and synthetic clothes.

#### • Shirt 30'

Use this program to prepare 2 shirts ready for ironing in 30 minutes.

#### • Delicates

You can dry your delicate clothes suitable for drying or clothes that are recommended for hand wash (silk blouses, thin underwear etc.) under low temperatures.



It is recommended to dry your delicates in a laundry bag to prevent wrinkles and damage. When the program ends, take out your laundry immediately and hang them to prevent wrinkles.

#### • Refresh

Ventilates for 10 minutes without blowing hot air. You can ventilate the cotton and linen clothes that have been enclosed for a long time with this program to remove their odour.

## Operating the product

### • **Timer programs**





You can select the 30 mins or 45 mins timer program to achieve the desired final drying level under low temperature.



In this program, the machine dries for the duration set, regardless of the drying level.

# Operating the product

## Program selection and consumption chart

EN					
Programmes		Capacity (kg)	Spin speed in washing machine (rpm)	Approximate amount of remaining humidity	Drying time (minutes)
Cottons / Coloreds					
	Extra dry	8	1000	% 60	190
	Cupboard dry	8	1000	% 60	179
	Iron dry	8	1000	% 60	150
Shirts		1,5	1200	% 60	50
Jeans		4	1200	% 50	120
Daily		4	1200	% 50	90
Sport		4	1000	% 60	105
Express		1	1200	% 50	45
Shirts 30		0,5	1200	% 60	30
Mixed		4	1000	% 60	90
Delicates		2	600	% 40	55
Synthetics					
	Cupboard dry	4	800	% 40	70
	Iron dry	4	800	% 40	55
Energy consumption values					
Programmes		Capacity (kg)	Spin speed in washing machine (rpm)	Approximate amount of remaining humidity	Energy consumption value kWh
Cottons linen Ready to wear*		8	1000	% 60	1,92
Cottons Ready to iron		8	1000	% 60	1,50
Synthetics Ready to wear		4	800	% 40	0,75
Power consumption of the off-mode for the standard cotton programme at full load, PO (W)					0,5
Power consumption of the left-on mode for the standard cotton programme at full load, PL (W)					1,0
Contains fluorinated greenhouse gases covered by the Kyoto Protocol. Hermetically sealed. R134a / 0,38 kg					



„Cotton cupboard dry Programme“ used at full and partial load is the standard drying Programme to which the information in the label and the fiche relates, that this Programme is suitable for drying normal wet cotton laundry and that it is the most efficient Programme in terms of energy consumption for cotton.

\* : Energy Label standard program (EN 61121:2012)

All the values on the chart are identified according to EN 61121:2012 standard. Consumption values may vary from the valued in the chart depending on laundry type, wringing speed, ambient conditions and voltage levels.

# Operating the product

## 5.6 Auxiliary functions

### Audible warning

 Machine makes an audible warning when the program is completed. To adjust the sound level, use the **Sound Warning Level** button.



You can change the sound level before the program starts or while the program continues..

## 5.7 Warning indicators



Warning indicators may vary depending on the model of your machine.

### Filter cleaning

When the program is completed, the warning indicator for filter cleaning turns on.

### Water tank

When the program is completed, the warning indicator to empty the water tank turns on.

If the water tank fills up while the program continues, the warning indicator starts flashing and the machine goes into stand-by. In this case, empty the water tank and start the program by pressing the **Start / Stand-by** button. Warning indicator turns off and program resumes.

### Time delay

You can delay the start of the program for up to 24 hours using the Time Delay function.

1. Open the loading door and place the laundry.
2. Select the drying program.
3. Press the Time Delay selection button and set the delay time you wish. Time Delay LED turns on. (If you keep the button pressed, the time delay switches continuously).
4. Press the **Start / Stand-by** button. Time Delay countdown begins.



You can add or remove laundry during the Time Delay duration. At the end of the Time Delay countdown, the Time Delay warning indicator turns off and drying begins

## Changing the time delay duration

If you want to change the duration during the countdown:

1. Press the **On/Off/Cancel** button for 3 seconds to cancel the program. Turn on the machine again and repeat the Time Delay steps for the duration you wish.
2. When your machine is turned on for the first time, it turns on with the declaration program (cotton wardrobe dry).

## Canceling the Time Delay function

If you want to cancel the Time Delay countdown and start the program immediately:

1. Press the **On/Off/Cancel** button for 3 seconds to cancel the program.
2. Press the **On/Off/Cancel** button to start you previously selected program.

## 5.7 Starting the program

Press the Start/Stand-by button to start the program. Start/Stand-by and Drying indicators turn on to show that program started.

## 5.8 Child Lock

The machine has a child lock which prevents the program flow from being interrupted when the buttons are pressed during a program. When the child lock is activated, all buttons on the panel except the **On/Off/Cancel** button are deactivated.

To activate the child lock, keep the Sound Warning and Child lock buttons pressed for 3 seconds.

The child lock has to be deactivated to be able to start a new program after the current program is finished or to be able to interfere with the program. To deactivate the child lock, keep the same buttons pressed for 3 seconds.



When the child lock is activated, the child lock warning indicator on the screen turns on.



Child lock deactivates when the machine is turned off and on by the **On/Off/Cancel** button.

When the child lock is active:

The machine runs, or in stand-by state the indicator symbols won't change upon changing the position of the program selection button.

## Operating the product

### 5.9 Changing the program after it is started

You can change the program you selected to dry your laundry with a different program after the machine starts running.

1. For example, to select Extra Dry instead of Iron Dry, pause the program by pressing the **Start / Stand-by** button for 1 second.
2. Select the Extra Dry program using the Program selection knob.
3. Press the **Start/Stand-by** button to start the program.

### Adding and removing clothes during stand-by

If you want to add or remove clothes to/from the machine after the drying program starts:

1. Press the Start/Stand-by button to put the machine in Stand-by state. The drying operation stops.
2. Open the loading door while in Stand-by state, and close the door after you remove or add laundry.
3. Press the Start/Stand-by button to start the program.



Adding laundry after the drying operation starts may cause the dried laundry inside the machine to mix with wet laundry and leave the laundry damp at the end of operation.



Adding or removing laundry during drying may be repeated as many times as you wish. But this operation continuously interrupts the drying operation, and thus increases program duration and energy consumption. So, it is recommended to add laundry before the program starts.



If a new program is selected by turning the program selection knob while the machine is in stand-by; the running program terminates and new program information is displayed on the screen.



**WARNING:** Do not touch the inner surface of the drum while adding or removing clothes during a continuing program. The drum surface is hot.

### 5.10 Cancelling the program

If you want to cancel the program and terminate the drying operation for any reason after the machine starts running, keep the **On/Off/Cancel** button pressed for 3 seconds.



**WARNING:** The inside of the machine shall be extremely hot when you cancel the program during machine operation, so run the ventilation program to allow it to cool down.

### 5.11 Program end

When the program ends, the Fibre Filter Cleaning and Water Tank warning symbols on the program observation indicator turn on. Loading door may be opened and machine becomes ready for another run.

To turn off the machine, press the **On/Off/Cancel** button.



If the laundry is not removed after the program is completed, the wrinkle prevention function activates for 2 hours to prevent the laundry inside the machine to get wrinkled. The program tumbles the laundry with 10-minute intervals to prevent them from wrinkling.



Clean the fibre filter after each drying. (See „Fibre filter and Loading door inner surface“)



Empty the water tank after each drying. (See „Emptying the water tank“)

## 6 Maintenance and cleaning

Service life of product extends and frequently experienced problems will be reduced if it is cleaned at regular intervals.

### 6.1 Cleaning Lint Filter / Loading Door Inner Surface

Lint and fibre released from the laundry to the air during the drying cycle are collected in the Lint Filter.



Such fibre and lint are generally formed during wearing and washing.



Always clean the lint filter and the inner surfaces of the loading door after each drying process.



You can clean the lint filter housing with a vacuum cleaner.

To clean the lint filter:

- Open the loading door.
- Remove the lint filter by pulling it up and open the lint filter.
- Clean lint, fibre, and cotton raveling by hand or with a soft piece of cloth.
- Close the lint filter and place it back into its housing.

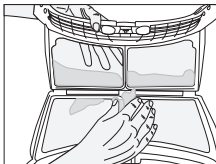
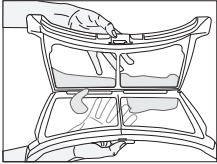
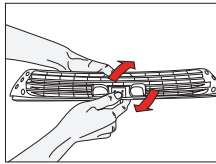
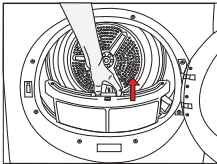

- A layer can build up on the filter pores that can cause clogging of the filter after using the dryer for a while. Wash the lint filter with warm water to remove the layer that builds up on the lint filter surface. Dry the lint filter completely before reinstalling it.

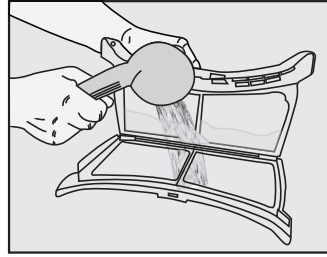

- Clean the entire inner surface of the loading door and loading door gasket with a soft damp cloth.

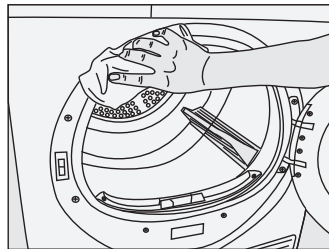
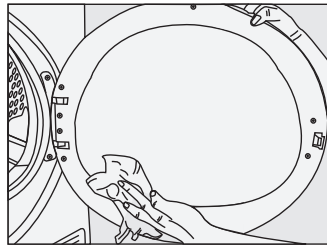



## Maintenance and cleaning

### 6.2 Cleaning the sensor

There are dampness sensors in the dryer that detect whether the laundry is dry or not.

To clean the sensors:

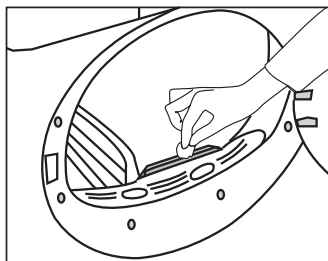

- Open the loading door of the dryer.
- Allow the machine to cool down if it is still hot due to the drying process.
- Wipe the metal surfaces of the sensor with a soft cloth, dampened with vinegar and dry them.

	Clean metal surfaces of the sensors 4 times a year.
	Do not use metal tools when cleaning metal surfaces of the sensors.
	Never use solvents, cleaning agents or similar substances for cleaning due to the risk of fire and explosion!



### 6.3 Draining the water tank

Dampness of the laundry is removed and condensed during drying process and the water that arise accumulates in the water tank. Drain the water tank after each drying cycle.

	Condensed water is not drinkable!
	Never remove the water tank when the program is running!

If you forget to drain the water tank, the machine will stop during the subsequent drying cycles when the water tank is full and the Water Tank warning symbol will flash. If this is the case, drain the water tank and press **Start / Pause** button to resume the drying cycle.

To drain the water tank:

Pull the drawer and remove the water tank carefully.

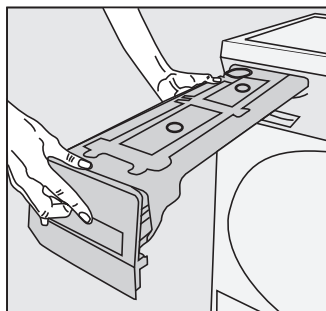

- Drain the water in the tank.

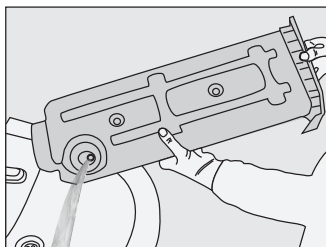

- If there is lint accumulation in the funnel of the water tank, clean it under running water.
- Place the water tank into its seat.

	If the direct water draining is used as an option, there is no need to empty the water tank.
---	--

## Maintenance and cleaning

### 6.4 Cleaning the filter drawer

Lint and fiber that could not be captured by the lint filter are blocked in the filter drawer behind the kick plate.

Warning light lights up periodically every 7 drying cycle maximum for reminding purposes on the products with filter drawer cleaning warning light .

A filter drawer foam placed on plastic is available inside the filter drawer.

To clean the filter drawer:

- Press the kick plate button to open the kick plate.

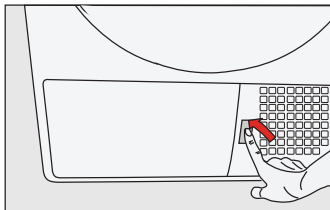

- Remove the filter drawer cover by turning it in the direction of arrow.

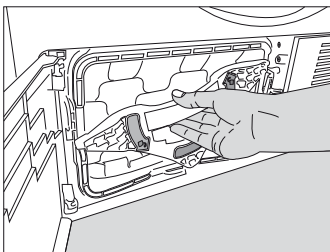

- Pull out the filter drawer.

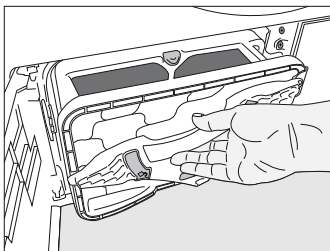

- Open the filter drawer by pressing the red button.

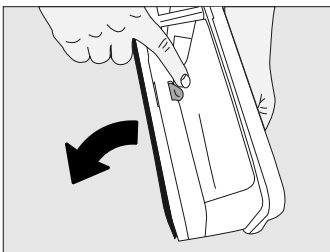

- Take out the filter drawer sponge.

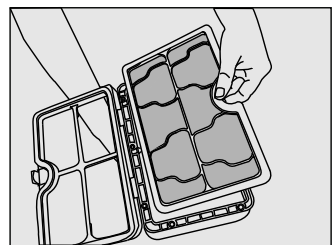
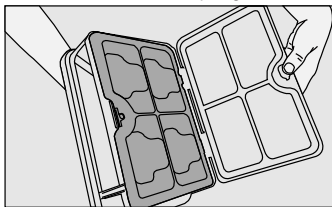

- Wash the filter drawer sponge by hand to remove the fiber and lint on the surface. After washing the sponge, squeeze it by hand and remove the excess water. Well-dry the sponge before storing it.



It is not necessary to clean the sponge if lint and fiber accumulation on it is not significant.

- Place the sponge back into its place.

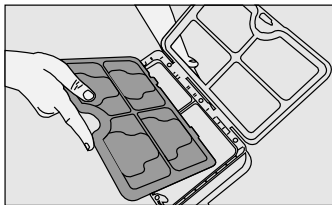

- Close the filter drawer as to lock the red button.

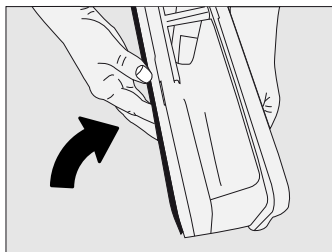

## Maintenance and cleaning

- Place the filter drawer back into its place, turn the filter drawer cover in the arrow direction and close it securely.

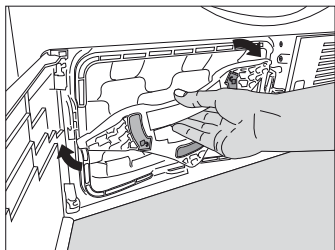

- Close the kick plate cover.

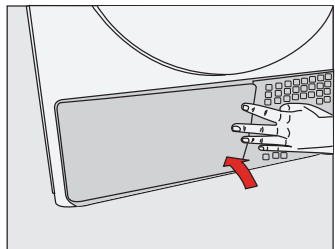

### 6.5 Cleaning the evaporator

Clean the lint accumulated on the fins of the evaporator located behind the filter drawer with a vacuum cleaner.

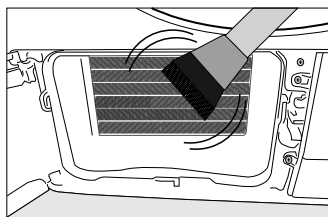
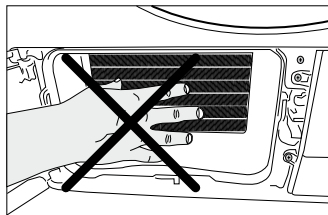

You can also clean by hand provided that you wear protective gloves. Do not attempt to clean with bare hands. Evaporator fins can harm your hand.



Drying without the filter drawer sponge in place will damage the machine!



A dirty lint filter and filter drawer will cause longer drying periods and higher energy consumption.

## 7 Troubleshooting

Drying process takes too much time.

- Pores of the lint filter are clogged. >>> Wash the lint filter with warm water.
- Filter drawer may be blocked>>>clean the foam inside the filter drawer.
- Ventilation grids on the front side of the machine are blocked. >>> Remove the objects (if any) that block ventilation in front of the ventilation grids.
- Ventilation is not sufficient since the room where the machine is installed is very small. Open the door and window of the room to avoid the room temperature increase too much.
- Lime deposit has built up on the dampness sensor. >>> Clean the dampness sensor.
- Excessive laundry is loaded. >>> Do not load the dryer in excess.
- Laundry is not spun sufficiently. >>> Spin your laundry at a higher speed in your washing machine.

Laundry comes out wet at the end of drying.



After drying, the hot clothes feel damper than their actual dampness level.

- It is likely that the selected programme did not suit the laundry type.>>>Checking the care labels on clothes, select appropriate programme for the laundry type or use timer programmes in addition.
- Pores of the lint filter are clogged. >>> Wash the lint filter with warm water.
- Filter drawer may be blocked>>>clean the foam inside the filter drawer.
- Excessive laundry is loaded. >>> Do not load the dryer in excess.
- Laundry is not spun sufficiently. >>> Spin your laundry at a higher speed in your washing machine.

Dryer does not switch on or the programme does not start. Dryer does not start when it is set.

- It is not plugged in. >>> Make sure that the machine is plugged in.
- The loading door is ajar. >>> Make sure that the loading door is closed securely.
- Programme is not selected or the Start / Pause / Cancel button is not pressed. >>> Make sure that the programme is selected and the machine is not in Pause mode.
- Childproof Lock is activated. >>> Deactivate the Childproof Lock.

Programme is interrupted without any cause.

- Loading door is ajar. >>> Make sure that the loading door is closed securely.
- There was a power failure. >>> Press Start / Pause / Cancel button to start the programme.
- Water tank is full. >>> Drain the water tank.

Laundry has shrunk, become felted or deteriorated.

- A programme suitable for the laundry type is not used. >>> Check the garment tag and select a programme suitable for the fabric type.

Drum lighting does not turn on. (On models with lamp)

- Dryer is not switched on with the On / Off button. >>> Make sure that the dryer is switched on.
- Lamp is defective. >>> Call Authorized Service Agent to have the lamp replaced.

End/Anti-creasing symbol is on.

- Anti-creasing programme is activated in order to prevent laundry that has remained in the machine from creasing. >>> Turn off the dryer and take out the laundry.

End symbol is on.

- Programme is over. Turn off the dryer and take out the laundry.

## Troubleshooting

Lint Filter Cleaning symbol is on.

- Lint filter is not cleaned. >>> Clean the lint filter.

Lint Filter Cleaning symbol is flashing.

- Filter housing is clogged with lints. >>> Clean the lint filter housing.
- A deposit has built up on the lint filter pores that may cause clogging. >>> Wash the lint filter with warm water.
- Filter drawer is clogged. >>> Clean the sponge and the filter cloth in the filter drawer.

Water leaks from the loading door

- Lint has accumulated on the inner surfaces of the loading door and on the surfaces of the loading door gasket. >>> Clean the inner surfaces of the loading door and the surfaces of the loading door gasket.

Loading door opens spontaneously.

- Loading door is ajar. >>> Push the loading door to close until you hear a locking sound.

Water Tank warning symbol is on/flashing.

- Water tank is full. >>> Drain the water tank.
- Water draining hose is bent. >>> If the product is connected directly to a wastewater drain, check the water drain hose.

Filter Drawer Cleaning warning symbol is flashing.

- Filter drawer is not cleaned. >>> Clean the sponge and the filter cloth in the filter drawer.



If you cannot eliminate the problem although you follow the instructions in this section, consult your dealer or the Authorized Service Agent. Never try to repair a nonfunctional product yourself.